



JININ ELECTRET CONDENSER MICROPHONE UNITS

MODEL EM-4015

OMNI DIRECTIONAL

1. SENSITIVITY

(0 dB=1V/ μ bar, 1KHz,
VCC=2V, RL=2.2K Ω)

- 38 \pm 2dB
- 40 \pm 2dB
- 42 \pm 3dB
- 44 \pm 3dB
- 46 \pm 3dB



2. CIRCUIT DIAGRAM

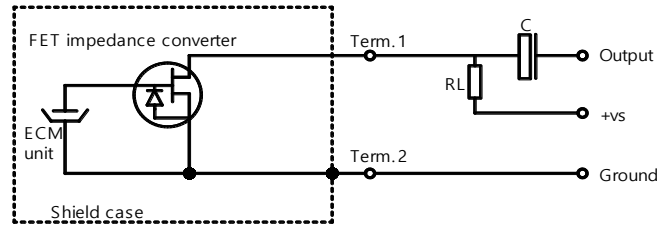

3. SPECIFICATIONS

1. IMPEDANCE : Less than 2.2K Ω
2. STANDARD VOLTAGE : 2.V
3. RANGE OF OPERATING VOLTAGE : 1.5V TO 10V
4. CURRENT DRAIN : 0.5mA MAX
5. S/N RATIO : 58 dB or more
6. MAXIMUM INPUT SOUND PRESSURE : 120 dB SPL
7. **RoHS Compliant.**

4. DIMENSION

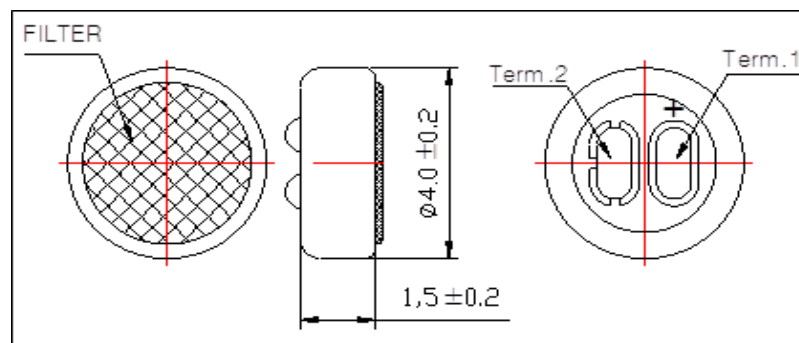

5. TYPICAL FREQUENCY RESPONSE CURVE

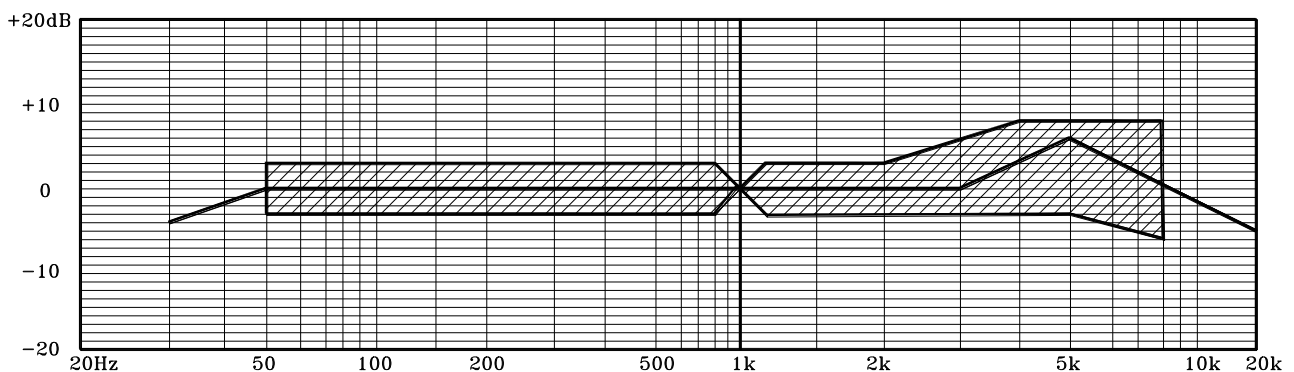

6. RELIABILITY TEST

VIBRATION TEST	TO BE NO INTERFERENCE IN OPERATION AFTER VIBRATION 12Hz TO 50Hz FOR 1 MINUTE FULL AMPLITUDE, FOR 1.5 HOUR AT 3 AXISES.
DROP TEST	TO BE NO INTERFERENCE IN OPERATION AFTER DROPPED TO CONCERTET FLOOR EACH ONE TIME FROM 1 METER HEIGHT AT 3 DIRECTONS IN STATE OF PACKING.
TEMPERATURE TEST	a) AFTER EXPOSURE AT 55° FOR 1 HOUR, SENSITIVITY TO BE WITHIN +/-3dB FROM INITIAL. b) AFTER EXPOSURE AT -10° FOR 1 HOUR, SENSITIVITY TO BE WITHIN +/-3dB FROM INITIAL. (THE MEASUREMENT TO BE DONE AFTER 2 HOURS OF CONDITIONING AT 25°C.)
HUMIDITY TEST	AFTER EXPOSURE AT 40°C AND 95% RH FOR 48 HOURS, SENSITIVITY TO BE WITHIN +/-3dB FROM INITIAL. (AFTER 1 HOUR OF CONDITIONING AT 25°C.)
TEMPERATURE CYCLE TEST	AFTER EXPOSURE AT -10°C FOR 1HOUR, AT 25°C FOR 1 HOUR, AT 50°C FOR 1 HOUR, ATO 25°C FOR 2 HOURS, 4 CYCLES ,SENSITIVITY TO BE WITHIN +/-3dB. (AFTER 2 HOURS OF CONDITIONING AT 25°C)

***REGARDING THE SOLDERING OPERATION :**

EACH CONDENSER MICROPHONE CONTAINS A FET WITHIN ITS CASE.

GENERALLY, OVER-HEATING, OVER-CHARGE OF VOLTAGE IS EASY TO DESTROY SEMICONDUCTORS.

1. USE 30W (OR UNDER) SOLDERING IRON AND MAINTAIN 230°~260°C IN OPERATION.
2. SOLDERING SHOULD BE ACCOMPLISHED WITHIN TWO SECONDS AT EACH TERMINAL SO AS NOT TO BE OVERHEATED.
3. DO NOT MAKE A CAVITY AT THE SERFACE OF LEAD ON THE PATTERN PLATE. (A CAVITY MAY CHANGE THE CHARACTERISTICE OF CONDENSER MICROPHONE.)



JIN IN ELECTRONIC CO., LTD

5F., NO 5-1, BAO HORNG RD., HSIN TIEN CITY ,TAIPEI, TAIWAN

TEL:886-2-29128689

FAX:886-2-29115517